

Article number: 208060141

Description: E+G Sphericalwasher female DIN 6319-14,2-D-NI
Stainless Steel 1.4305

Measures

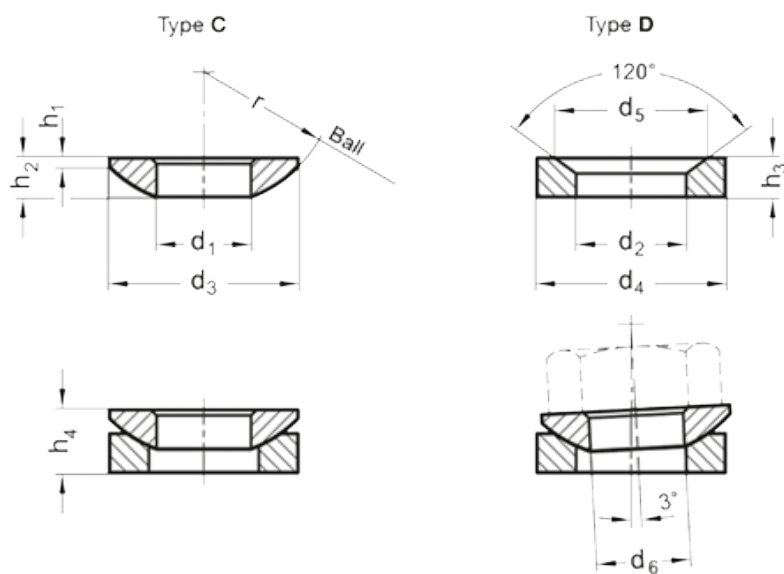

$d_2 = 14.2$

$d_4 = 24$

$d_5 = 20.0$

$d_6 = M12$

$H_3 = 5.0$

$H_4 = 8.0$